

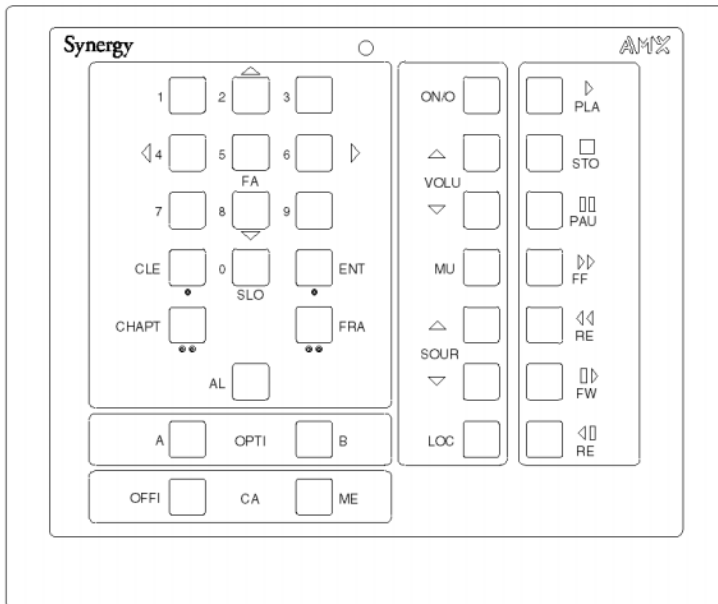

TX-CT5

Classroom Transmitter



AMX Limited Warranty and Disclaimer

AMX Corporation warrants its products to be free of defects in material and workmanship under normal use for three (3) years from the date of purchase from AMX Corporation, with the following exceptions:

- Electroluminescent and LCD Control Panels are warranted for three (3) years, except for the display and touch overlay components that are warranted for a period of one (1) year.
- Disk drive mechanisms, pan/tilt heads, power supplies, MX Series products, and KC Series products are warranted for a period of one (1) year.
- Unless otherwise specified, OEM and custom products are warranted for a period of one (1) year.
- Software is warranted for a period of ninety (90) days.
- Batteries and incandescent lamps are not covered under the warranty.

This warranty extends only to products purchased directly from AMX Corporation or an Authorized AMX Dealer.

AMX Corporation is not liable for any damages caused by its products or for the failure of its products to perform. This includes any lost profits, lost savings, incidental damages, or consequential damages. AMX Corporation is not liable for any claim made by a third party or by an AMX Dealer for a third party.

This limitation of liability applies whether damages are sought, or a claim is made, under this warranty or as a tort claim (including negligence and strict product liability), a contract claim, or any other claim. This limitation of liability cannot be waived or amended by any person. This limitation of liability will be effective even if AMX Corporation or an authorized representative of AMX Corporation has been advised of the possibility of any such damages. This limitation of liability, however, will not apply to claims for personal injury.

Some states do not allow a limitation of how long an implied warranty last. Some states do not allow the limitation or exclusion of incidental or consequential damages for consumer products. In such states, the limitation or exclusion of the Limited Warranty may not apply. This Limited Warranty gives the owner specific legal rights. The owner may also have other rights that vary from state to state. The owner is advised to consult applicable state laws for full determination of rights.

EXCEPT AS EXPRESSLY SET FORTH IN THIS WARRANTY, AMX CORPORATION MAKES NO OTHER WARRANTIES, EXPRESSED OR IMPLIED, INCLUDING ANY IMPLIED WARRANTIES OF MERCHANTABILITY OR FITNESS FOR A PARTICULAR PURPOSE. AMX CORPORATION EXPRESSLY DISCLAIMS ALL WARRANTIES NOT STATED IN THIS LIMITED WARRANTY. ANY IMPLIED WARRANTIES THAT MAY BE IMPOSED BY LAW ARE LIMITED TO THE TERMS OF THIS LIMITED WARRANTY.

Table of Contents

Product Information	1
Setting the IR Frequency.....	1
Using the TX-CT5	3
Television Control.....	3
Modes.....	3
Local Mode.....	3
Media Mode	3
Office, Security, or Media Center Control.....	4
Calls	4
System Media Control	4
Motion	4
Laser Disc	4
VCR.....	5
CD-I Player.....	5
Computer.....	5
Slides.....	5

Product Information

The AMX Synergy Classroom Transmitter (TX-CT5) provides a full range of control options for the AMX Synergy Resource Management System (RMS). It transmits Infrared (IR) format commands to classroom Television Managers.

TX-CT5 Specifications	
Dimensions (HWD):	5.25" (133 mm) x 6.26" (159 mm) x 0.75" (19.05 mm)
Weight:	8.4 oz (213.3 grams)
Frequency:	38 kHz - 455 kHz
Frequency options:	<ul style="list-style-type: none"> • High-frequency IR (455 kHz) avoids interference with electronic ballasts • Optional low frequency (38 kHz) to operate with existing AXB-TM installations
LED indicators:	Six high-output IR LEDs
Power:	Four 1.5 VDC N-size batteries
Enclosure:	High-impact molded enclosure
Buttons:	<ul style="list-style-type: none"> • ALT and OPTION buttons select special control options • LOCAL button selects local video source for receivers/monitors

Setting the IR Frequency

1. Remove the battery cover.
2. Set the DIP switch for the correct IR frequency
 - Set the switch position down for 455 kHz.
 - Set the switch position up for 38 kHz.

Using the TX-CT5

Television Control

The TV control buttons operate the classroom television. The following functions are always available:

- ON/OFF turns on or off the classroom television power.
- VOLUME controls the television volume. Press the up or down arrows to manipulate the volume.
- MUTE activates or deactivates the volume mute option.
- OPTION accesses optional control functions for local television display. Press OPTION B, one of the following number buttons, then ENTER:

- 1 Line 1 select
- 2 Line 2 select
- 3 Closed Caption on/off

- The following functions are for televisions with a local VCR connected to the same AXB-TM:

- 4 Tracking up
- 5 Tracking down
- 6 Reset counter
- 7 Clear
- 9 Text display on/off

Modes

The TX-CT5 has two operation modes: *Local Mode* and *Media Mode*.

Local Mode

The Local Mode is active whenever one of the following occurs:

- There is no media scheduled to that classroom.
- Press SOURCE \triangle (up) to select the next instructional channel.
- Press SOURCE ∇ (down) to select the previous instructional channel.

Media Mode

The Media Mode is active whenever there is a media source, broadcast channel, or media plan scheduled to a classroom. You can select up to 10 sources.

- Press SOURCE \triangle (up) to pause current media, select next source assignment, and play assigned media source.
- Press SOURCE ∇ (down) to pause current media, select previous source assignment, and play assigned media source.

Office, Security, or Media Center Control

Calls

There are two different kinds of calls that you can send:







- **Office:** To send a general emergency call signal to the Paging Console (AXP-PC) or to a Security Panel (AXU-SPL4) press OFFICE then ENTER. To clear the call before you receive a response press OFFICE then CLEAR.
- **Media:** To send a general call to the media center's computer press MEDIA then ENTER.

System Media Control

The TX-CT5 has a standard set of motion control buttons located on the right side.

Motion

To control the motion of the media, use the following seven buttons:

	PLAY
	STOP
	PAUSE
	FFWD (Fast forward)
	REV (Rewind)
	FWD (Step forward)
	REV (Step reverse)

Laser Disc

The selected source must accept a Chapter command.

- **Chapter:** To play a specific chapter, press CHAPTER, the chapter number then ENTER.
- **Frame:** To play a specified frame, press FRAME, the frame number, then ENTER.
- **Clear:** To cancel commands, press CLEAR, then ENTER.
- **Audio:** To control audio, press ALT and one of the following number buttons:
 - 1 Left channel (analog)
 - 2 Right channel (analog)
 - 3 Both channels
 - 4 All channels mute (analog)
 - 5 Left channel (digital)
 - 6 Right channel (digital)
 - 7 Both channels (digital)
 - 8 All channels mute (digital)
 - 9 Text display on
 - 0 Side A/B select (if available)

VCR

1. To access an optional feature, press ALT,
2. Then, choose one of the following number buttons and press ENTER:

- 4 Tracking up
- 5 Tracking down
- 6 Reset counter
- 7 Clear
- 9 Text display on/off

CD-I Player

To control the CD-I mouse, use the buttons labeled in yellow. Then, press one of the eight outer number buttons (1 – 4 or 6 – 9). Select from four mouse speeds.

5 increases mouse speed while 0 decreases it.

To activate CD-I functions:







- Press the right ● button (ENTER) or the left ● button (CLEAR) to activate the first CD-I function button.
- Press the right ●● button (FRAME) or the left ●● button (CHAPTER) to activate the second CD-I function button.

Computer

To control the CD-I mouse, use the buttons labeled in yellow. Then, press one of the eight outer number buttons (1 – 4 or 6 – 9). For information on the Speed and how to activate functions refer to the CD-I Player subsection.

Slides

To control video slide projectors and still video players, use the following buttons::

-  PLAY (slides on)
-  STOP (slides off)
-  PAUSE (still video standby)
-  FFWD (zoom in)
-  REV (zoom out)
-  FWD (forward)
-  REV (reverse)



AMX reserves the right to alter specifications without notice at any time.

brussels • dallas • los angeles • mexico city • philadelphia • shanghai • singapore • tampa • toronto • york
3000 research drive, richardson, TX 75082 USA • 469.624.8000 • 800.222.0193 • fax 469.624.7153 • technical support 800.932.6993

045-004-1084 7/01 ©2001 AMX Corporation. All rights reserved. AMX, the AMX logo, the building icon, the home icon, and the light bulb icon are all trademarks of AMX Corporation. AMX reserves the right to alter specifications without notice at any time. In Canada doing business as Pajja Inc.